

RELIABILITY TEST DATA

Safety Standard Certified Lead Type Disc Ceramic Capacitors for General Purpose

MURATA PN : DE11XRA680K*P01F**

Type RA

Rated Voltage(Y1) : AC300V(r.m.s.)

	PAGE
1. TEMPERATURE CHARACTERISTIC	... 1
2. ROBUSTNESS of TERMINATIONS	... 1
3. SOLDERABILITY of LEADS	... 2
4. SOLDERING EFFECT	... 3
5. HUMIDITY (UNDER STEADY STATE)	... 4
6. HUMIDITY LOADING	... 5
7. LIFE (HIGH TEMPERATURE LOADING)	... 6
8. FLAME TEST	... 7
9. ACTIVE FLAMMABILITY	... 8
10. PASSIVE FLAMMABILITY	... 9
11. TEMPERATURE & IMMERSION CYCLE	... 10

1. TEMPERATURE CHARACTERISTIC

Condition : 1.0 kHz, 1.0 V(r.m.s.)

Specification : Between -1000 and +350 ppm/°C
 (Temp. Range : 20 to 85 °C, Reference Temp. : 20 °C)

Sample Qty. : 5 pcs.

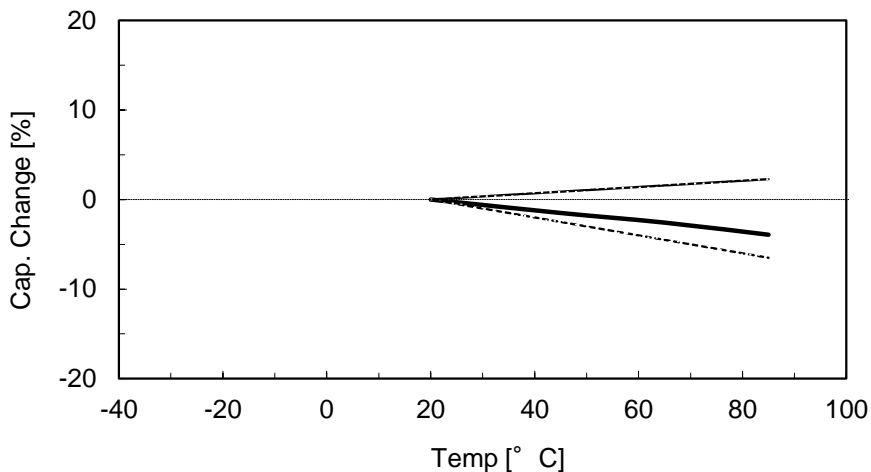

2. ROBUSTNESS of TERMINATIONS

Condition : < TENSILE >

Fix the body of capacitor, and apply a tensile weight gradually to each lead wire in the radial direction of capacitor up to 10 N and keep it for 10 s.

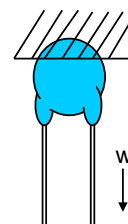

< BENDING >

Each lead wire shall be subjected to 5 N weight and then a 90° bend, at the point of egress, in one direction return to original position, and then a 90° bend in the opposite direction at the rate of one bend in 2 to 3 s.

Specification : Lead wire should not cut off.
 Capacitor should not be broken.

Result :

No.	TENSILE	BENDING
1	OK	OK
2	OK	OK
3	OK	OK
4	OK	OK
5	OK	OK
6	OK	OK
7	OK	OK
8	OK	OK
9	OK	OK
10	OK	OK

3. SOLDERABILITY of LEADS

Condition : The lead wire of a capacitor should be dipped into a ethanol solution of 25wt% rosin and then into molten solder (Sn-3Ag-0.5Cu) of 245 °C for 2 s.

Specification : Lead wires should be soldered with uniformly coated on the axial direction over 3/4 of the circumferential direction.

Sample Qty. : 10 pcs.

No.	RESULT
1	OK
2	OK
3	OK
4	OK
5	OK
6	OK
7	OK
8	OK
9	OK
10	OK

4. SOLDERING EFFECT

< Non-preheat >

Condition : Solder temp. ... 350 °C
 Immersion time ... 3.5 s
 Post-treatment ... Place at room condition for 1 to 2 h.

Sample Qty. : 10 pcs.

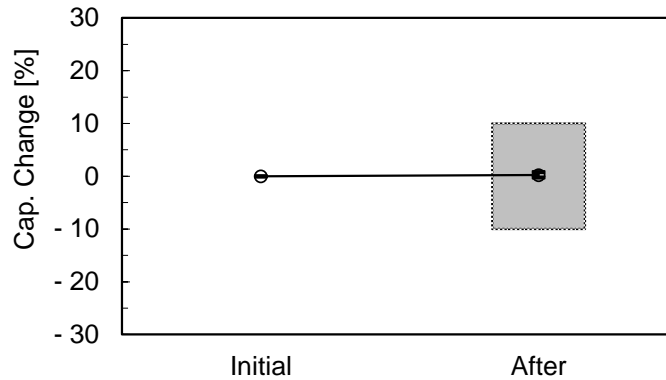

Spec.

Within $\pm 10\%$

(Dielectric Strength) AC4000V(r.m.s.),60 s
 Dielectric Strength (Between lead wires) : No failure
 Dielectric Strength (Body Insulation) : No failure
 Insulation Resistance (I.R.) : 1000M Ω min.
 Appearance : No marked defect

<On-preheat >

Condition : Pre-heat ... 120 °C, 60 s
 Solder temp. ... 260 °C
 Immersion time ... 7.5 s
 Post-treatment ... Place at room condition for 1 to 2 h.

Sample Qty. : 10 pcs.

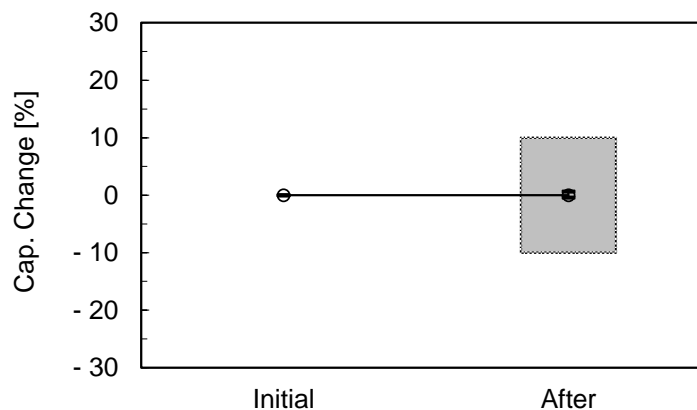

Spec.

Within $\pm 10\%$

(Dielectric Strength) AC4000V(r.m.s.),60 s
 Dielectric Strength (Between lead wires) : No failure
 Dielectric Strength (Body Insulation) : No failure
 Insulation Resistance (I.R.) : 1000M Ω min.
 Appearance : No marked defect

5. HUMIDITY (UNDER STEADY STATE)

Condition : Temperature ... 40 °C
 Relative humidity ... 95%
 Duration ... 500 h

Post-treatment ... Place at room condition for 1 to 2 h.

Sample Qty. : 10 pcs.

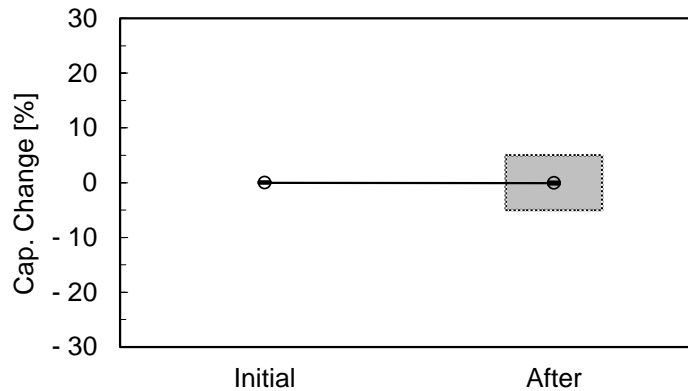

Spec.

Within $\pm 5\%$

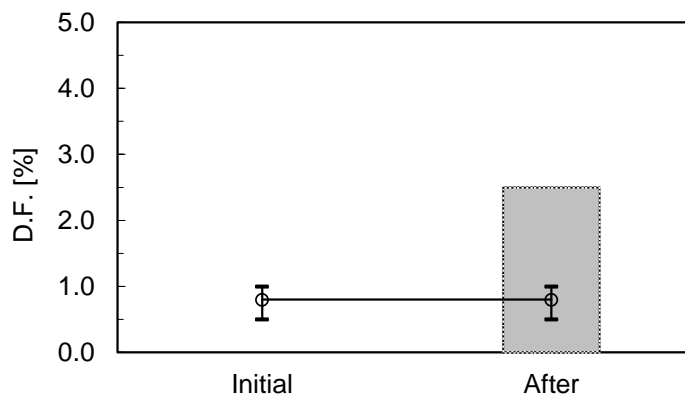

Spec.

2.5 % max.

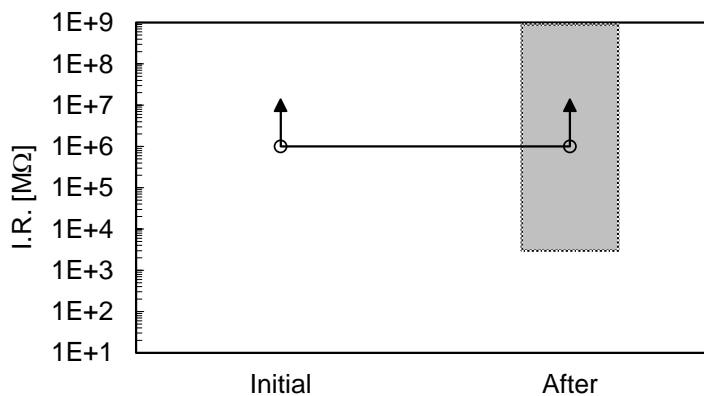

Spec.

3,000 MΩ min.

(Dielectric Strength) AC4000V(r.m.s.),60 s
 Dielectric Strength (Between lead wires) : No failure
 Dielectric Strength (Body Insulation) : No failure
 Appearance : No marked defect

6. HUMIDITY LOADING

Condition : Temperature ... 40 °C
 Relative humidity ... 95%
 Voltage ... AC440V
 Duration ... 500 h
 Post-treatment ... Place at room condition for 1 to 2 h.

Sample Qty. : 10 pcs.

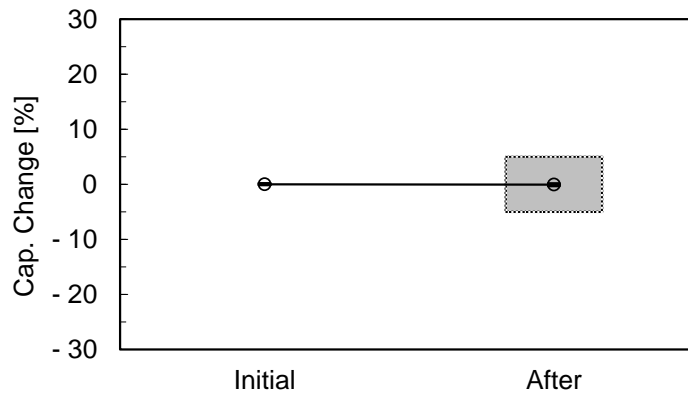

Spec.

Within $\pm 5\%$

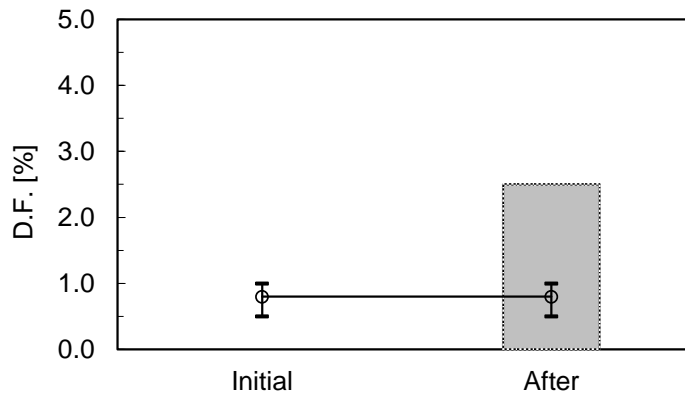

Spec.

2.5 % max.

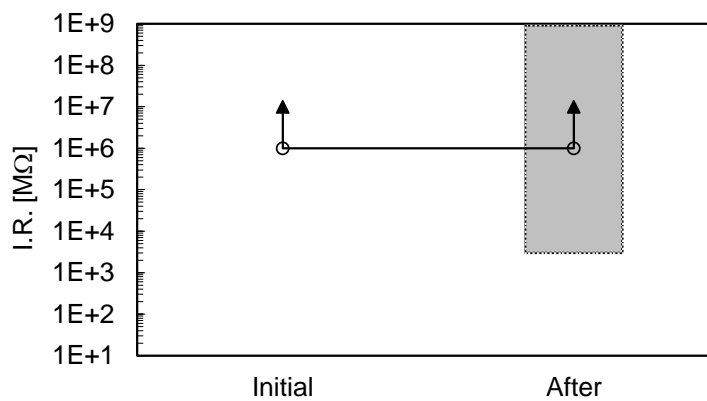

Spec.

3,000 MΩ min.

(Dielectric Strength) AC4000V(r.m.s.),60 s
 Dielectric Strength (Between lead wires) : No failure
 Dielectric Strength (Body Insulation) : No failure
 Appearance : No marked defect

7. LIFE (HIGH TEMPERATURE LOADING)

Condition	: Temperature	... 125°C
	: Voltage	... AC 550 V(r.m.s.) [Once each hour the voltage is increased to AC 1,000 V(r.m.s.) for 0.1 s.]
	: Duration	... 1,000 h
	: Before-life test	... Each individual capacitor shall be subjected to a 8 kV impulses.
	: Post-treatment	... Place at room condition for 24 h.

Sample Qty. : 10 pcs.

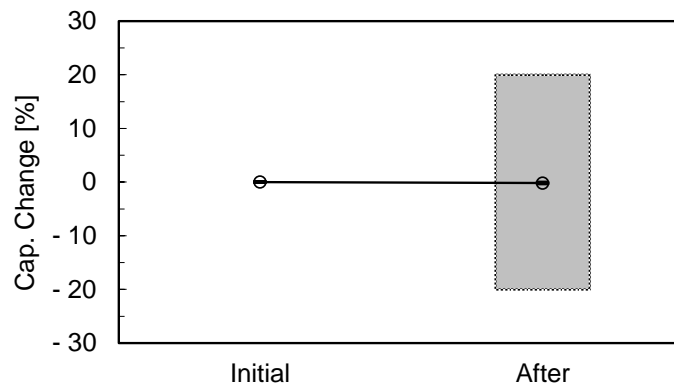

Spec.

Within $\pm 20\%$

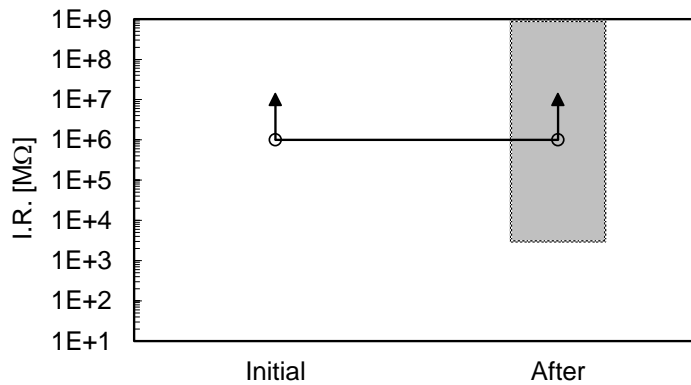

Spec.

3,000 MΩ min.

(Dielectric Strength) AC4000V(r.m.s.),60 s
 Dielectric Strength (Between lead wires) : No failure
 Dielectric Strength (Body Insulation) : No failure
 Appearance : No marked defect

8. FLAME TEST

Condition : The capacitor shall be subjected to applied flame for 15 s, and then removed for 15 s until 5 cycles.

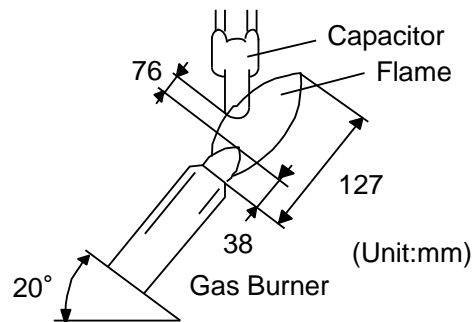

Sample Qty. : 10 pcs.

Specification : The capacitor flame discontinue as follows.

Cycle	Time
1 - 4	30 s max.
5	60 s max.

Result :

No.	Result
1	OK
2	OK
3	OK
4	OK
5	OK
6	OK
7	OK
8	OK
9	OK
10	OK

9. ACTIVE FLAMMABILITY

Condition : The capacitors shall be individually wrapped in at least one but more than two complete layers of cheese-cloth. The capacitor shall be subjected to 20 discharges. The interval between successive discharges shall be 5 s. The U_{AC} shall be maintained for 2 min after the last discharge.

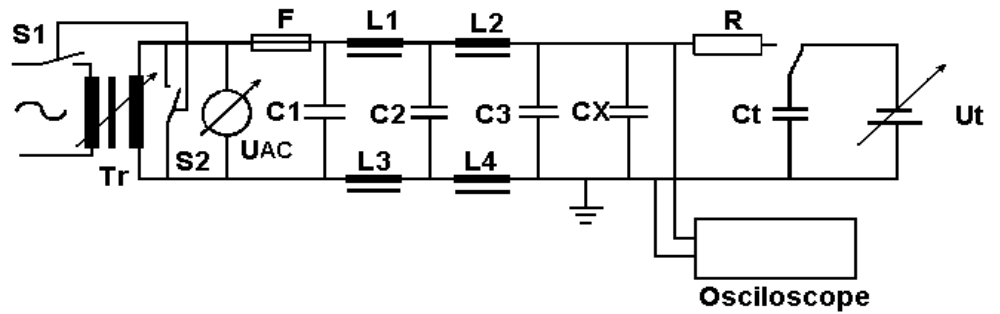

- | | | | |
|-------|--------------------------------|----------|-------------------------|
| C1,C2 | : 1 μ F \pm 10% | L1 to 4 | : 1.5 mH \pm 20% |
| C3 | : 0.033 μ F \pm 5% 10 kV | | 16 A Rod core choke |
| Ct | : 3 μ F \pm 5% 10 kV | R | : 100 Ω \pm 2% |
| Cx | Capacitor under test | U_{AC} | : $U_R \pm 5\%$ |
| F | Fuse, Rated 10 A | U_R | : Rated Voltage |
| | | U_t | : Voltage applied to Ct |

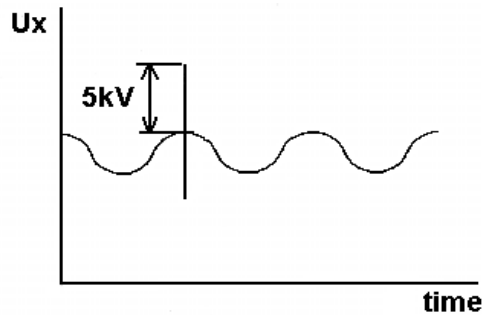

Sample Qty. : 10 pcs.

Specification : The cheese-cloth shall not be on fire.

No.	RESULT
1	OK
2	OK
3	OK
4	OK
5	OK
6	OK
7	OK
8	OK
9	OK
10	OK

10. PASSIVE FLAMMABILITY

Condition : The capacitor under test shall be held in the flame in the position which best promotes burning. Each Specimen shall only be exposed once to the flame.
Time of exposure to flame : 30 s.

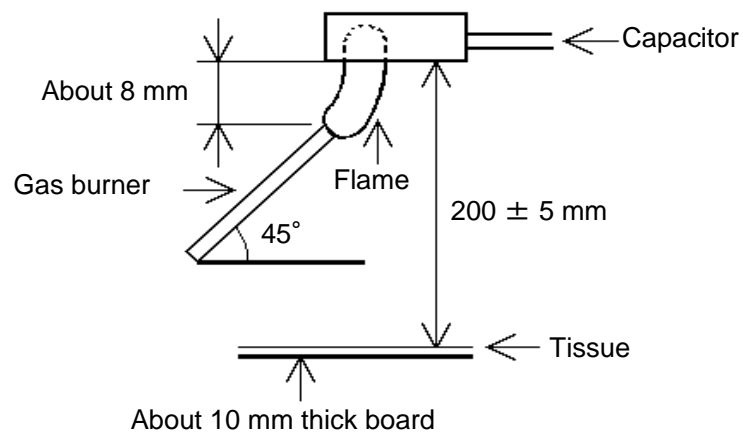

Length of flame : 12 ± 1 mm
 Gas burner : Length 35 mm min.
 Inside Dia. : 0.5 ± 0.1 mm
 Outside Dia. : 0.9 mm max.
 Gas : Butane gas Purity 95% min.

Sample Qty. : 10 pcs.

Specification : The burning time shall not be exceeded the time 30 s.
The tissue paper shall not ignite.

No.	RESULT
1	OK
2	OK
3	OK
4	OK
5	OK
6	OK
7	OK
8	OK
9	OK
10	OK

11. TEMPERATURE & IMMERSION CYCLE

Condition : The capacitor shall be subjected to 5 temperature cycles, then consecutively to 2 immersion cycles.

< Temperature cycle / Cycle time : 5 cycles>

Step	1	2	3	4
Temp.[°C]	-40	Room Temp.	125	Room Temp.
Time[min]	30	2 to 3	30	2 to 3

< Immersion cycle / Cycle time : 2 cycles>

Step	Temp.[°C]	Time[min]	Immersion water
1	65	15	Clean water
2	0	15	Saturated salt water

Post-treatment ... Place at room condition for 24 h.

Sample Qty. : 10 pcs.

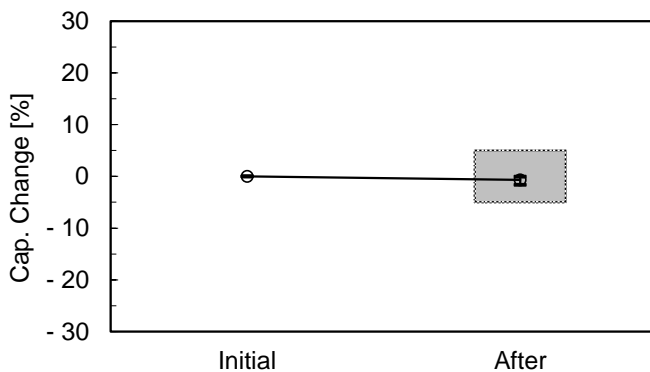

Spec.

Within $\pm 5\%$

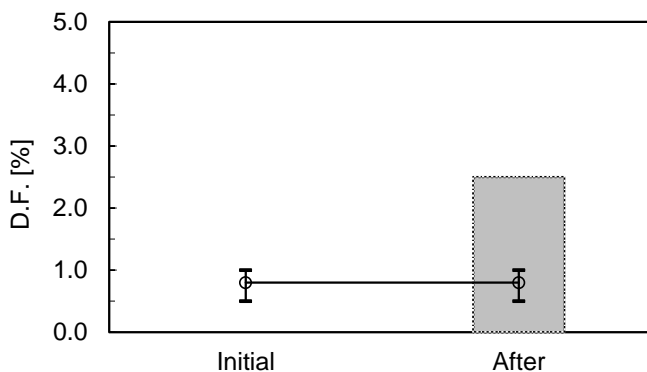

Spec.

2.5 % max.

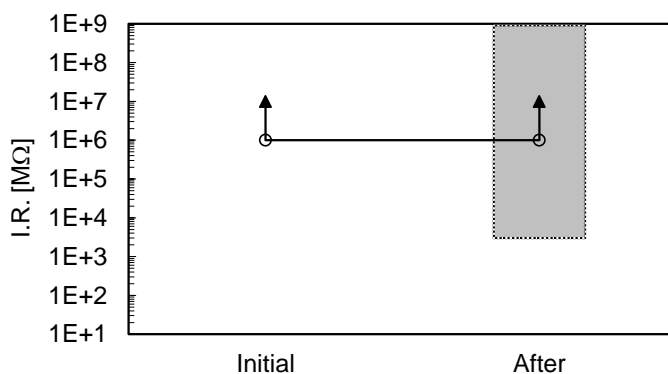

Spec.

3,000 MΩ min.

(Dielectric Strength) AC4000V(r.m.s.),60 s
 Dielectric Strength (Between lead wires) : No failure
 Dielectric Strength (Body Insulation) : No failure
 Appearance : No marked defect